

Möbelgriffe

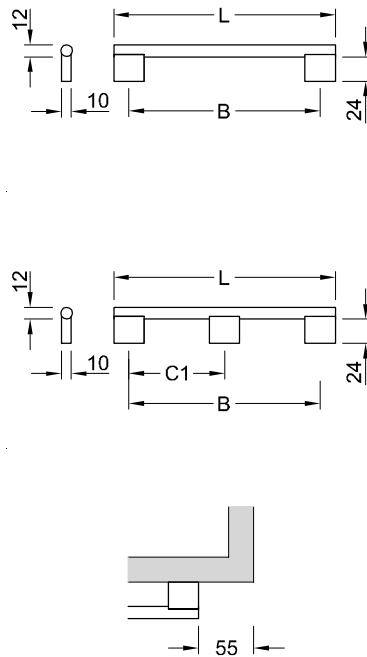

Möbelgriff FERNANDO

Edelstahl geschliffen Korn 240
Stangendurchmesser: 12 mm; Gewinde M4

Art.Nr.	Länge L	Bohr- abstand B	Bohr- abstand C1
mit 2 Sockeln			
040-0031	126	96	
040-0118	158	128	
040-0032	190	160	
040-0180	222	192	
040-0181	240	210	
040-0182	290	260	
040-0033	318	288	
040-0183	340	310	
040-0034	382	352	
040-0184	390	360	
040-0185	440	410	
040-0035	478	448	
040-0186	490	460	
040-0187	590	560	
040-0188	690	660	
mit 3 Sockeln			
040-0189	790	760	380
040-0190	890	860	430
040-0191	990	960	480
040-0038	1310	1280	640
040-0039	1758	1728	864

Gerne fertigen wir Ihre Wunschlänge.
Polierte Oberfläche auf Anfrage.

10

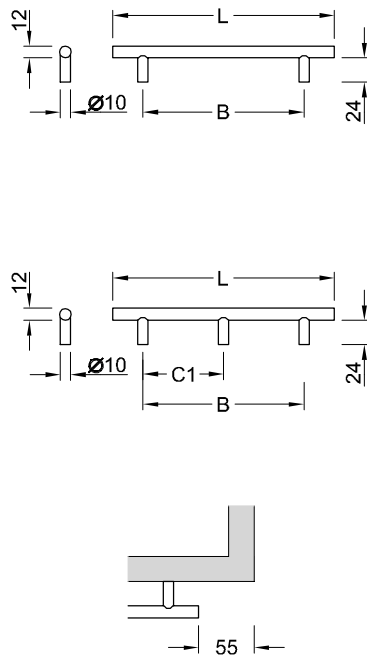

Möbelgriff PEDRO

Edelstahl geschliffen Korn 240
Stangendurchmesser: 12 mm; Gewinde M4

Art.Nr.	Länge L	Bohr- abstand B	Bohr- abstand C1
mit 2 Sockeln			
040-0200	136	96	
040-0201	168	128	
040-0202	200	160	
040-0203	232	192	
040-0204	250	210	
040-0205	300	260	
040-0206	328	288	
040-0207	350	310	
040-0208	392	352	
040-0209	400	360	
040-0210	450	410	
040-0211	488	448	
040-0212	500	460	
040-0213	600	560	
040-0214	700	660	
mit 3 Sockeln			
040-0215	800	760	380
040-0216	900	860	430
040-0217	1000	960	480
040-0218	1200	1160	580
040-0219	1400	1360	680
040-0220	1600	1560	780
040-0221	1800	1760	880
040-0222	2000	1960	980

Gerne fertigen wir Ihre Wunschlänge.
Polierte Oberfläche auf Anfrage.

Möbelgriffe

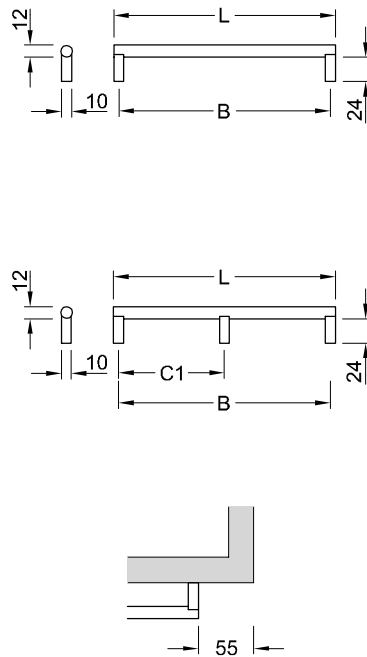

Möbelgriff DINO

Edelstahl geschliffen Korn 240
Stangendurchmesser: 12 mm; Gewinde M4

Art.Nr.	Länge L	Bohr- abstand B	Bohr- abstand C1
mit 2 Sockeln			
040-0022	108	96	
040-0117	140	128	
040-0023	172	160	
040-0250	204	192	
040-0251	236	224	
040-0024	300	288	
040-0252	332	320	
040-0025	364	352	
040-0026	460	448	
040-0027	620	608	
mit 3 Sockeln			
040-0028	780	768	384
040-0029	1292	1280	640
040-0030	1740	1728	864

Gerne fertigen wir Ihre Wunschlänge.
Polierte Oberfläche auf Anfrage.

10

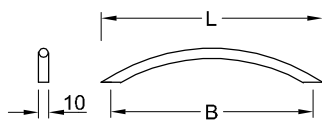

Möbelgriff RAPHAELE

Edelstahl V2A geschliffen Korn 240
Stangendurchmesser: 10 mm; Gewinde M4

Art.Nr.	Länge L	Bohrabstand B
040-0048	111	96
040-0049	145	128
040-0050	183	160
040-0051	223	192

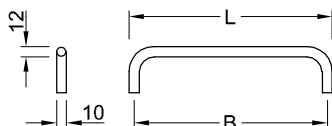

Möbelgriff DA VINCI

Edelstahl V2A geschliffen Korn 240
Stangendurchmesser: 10 mm; Gewinde M4

Art.Nr.	Länge L	Bohrabstand B
040-0040	106	96
040-0041	138	128
040-0042	170	160
040-0043	202	192
040-0044	234	224
040-0045	330	320
040-0046	426	416
040-0047	522	512

Möbelknöpfe

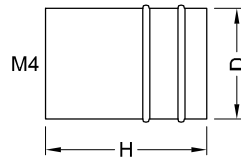

Möbelknopf DANİ

Edelstahl geschliffen Korn 240
mit O-Ring Einsatz schwarz

Gewinde M4

Art.Nr.	Durchmesser D	Höhe H
040-0067	13	22
040-0068	22	32

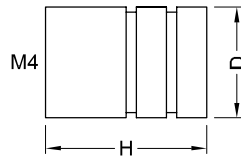

Möbelknopf EDUARD

Edelstahl geschliffen Korn 240

Gewinde M4

Art.Nr.	Durchmesser D	Höhe H
040-0063	13	22
040-0064	18	27
040-0065	22	32

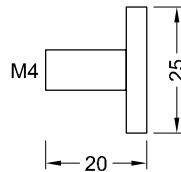

Möbelknopf TOM

Edelstahl geschliffen Korn 240

Gewinde M4

Art.Nr.	Durchmesser D	Höhe H
040-0066	25	20

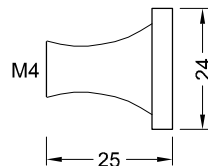

Möbelknopf LUKAS

Edelstahl geschliffen Korn 240

Gewinde M4

Art.Nr.	Durchmesser D	Höhe H
040-0062	24	25

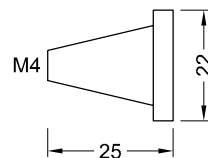

Möbelknopf FELIDEA

Edelstahl geschliffen Korn 240

Gewinde M4

Art.Nr.	Durchmesser D	Höhe H
040-0061	22	25